

# 3401-004 Coaxial / 3401-040 Power D\*M Contacts

## Features/Benefits

- Coaxial contact Up to 1GHz
- Power Contacts from 10 to 40 A
- Straight or 90° solder or crimp
- Straight or 90° PCB termination

## Typical Applications

- Space equipment
- Avionics/Military
- Industrial applications



## Product Features

Loose size 8 contacts for combination arrangement D\*M connectors **must be ordered separately**. NO NMC type available.

**Signal contacts are installed in factory.**

**Signal contact are solder bucket type. Other type could be asked under request.**

Coaxial contacts, straight or 90°, solder or crimp type

- Plug (male), with female center contact, for installation on D\*M plug connectors (and on the central cavity of receptacle connectors 3WK3)
- Receptacle (female), with male center contact, for installation on D\*M receptacle connectors (and on the central cavity of plug connectors 3WK3)

Power contacts, straight, or 90°, solder or crimp type

- Plug (male), for installation on D\*M plug connectors (and on the central cavity of receptacle connectors 3WK3)
- Receptacle (female), for installation on D\*M receptacle connectors (and on the central cavity of plug connectors 3WK3)

Packaging unit

- 1 piece (plastic bag) for ESA/ESCC quality level
- 25 pieces (plastic bag) for FR023 quality level
- 25 pieces (plastic bag) for FR022 quality level

## Specific Performance Specifications

### All Contacts

Contact Retention in Insert	65 N max / contact axial displacement 0,50 (.020) max
Contact Insertion Force (from the rear)	55 N min (locking) / 65 N max (no damage)
Retainer Force (from the front)	50 N min (no unlocking)
Residual magnetism level	NMB (200 Gamma max)

### Coaxial Contacts

Frequency Range	Up to 1 GHz
VSWR (up to 1 GHz)	1.4
RF Insertion Loss at 1 GHz	0.2 dB
Soldering Temperature	260 °C / 10 seconds max
Contact Engagement Force	Outer contact (Receptacle): 0.83 N min, pin dia 3,86 (.152) / 6.87 N max, pin dia 3,86 (.152) Center contact (Plug): 0.28 N min, pin dia 0,99 (.039) / 3.33 N max, pin dia 1,04 (.041)
Contact Separation Force	Outer contact (Receptacle): 0.83 N min, pin dia 3,86 (.152) / 6.87 N max, pin dia 3,86 (.152) Center contact (Plug): 0.28 N min, pin dia 0,99 (.039) / 2.22 N max, pin dia 1,04 (.041)
Contact Resistance (center contact)	8.5 mΩ max (low level current) / 7.0 mΩ max (rated level current)
Voltage Proof (center / outer contacts)	1000 Vrms (straight rear end) / 800 Vrms (90° rear end)

### Power Contacts

Rated Current	40 A at T amb 60°C max / Limitation by the current carrying capability of the cable
Soldering Temperature	260 °C / 10 seconds max
Contact Engagement Force	(Receptacle): 0.83 N min, pin dia 3,58 (.141) / 6.87 N max, pin dia 3,63 (.143)
Contact Separation Force	(Receptacle): 0.83 N min, pin dia 3,58 (.141) / 5.56 N max, pin dia 3,63 (.143)
Contact Resistance	2.5 mΩ max (low level current) / 2.0 mΩ max (rated level current)

# 3401-004 Coaxial / 3401-040 Power D\*M Contacts

## Coaxial Contacts

### Straight Solder/or Crimp Braid Type

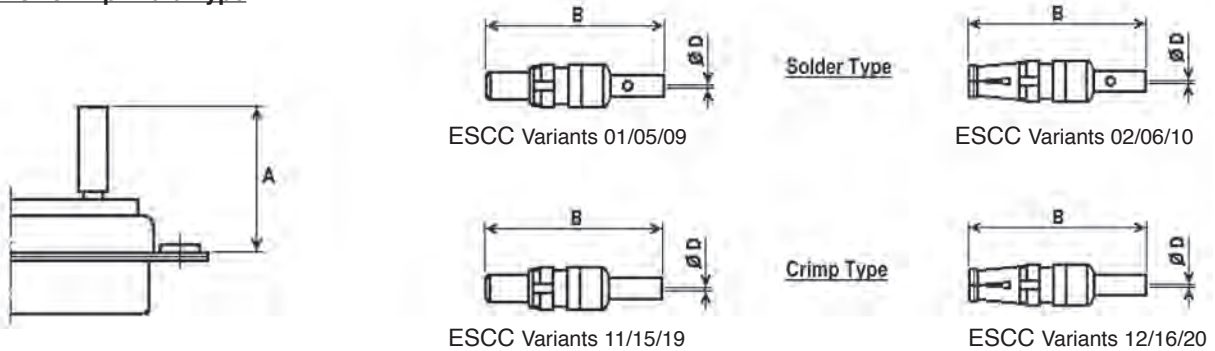

ESA/ESCC 3401 -004 xx Variant	Type	A max	B ± 0,60 (.024)	D ± 0,13 (.005)	Accepted Cables	Max Weight (grams)
01 (solder) / 11 (crimp)	Male	18,80 (.740)	23,62 (.930)	1,02 (.040)	178 B/U - 196 A/U - KX 21A	1.4
02 (solder) / 12 (crimp)	Female	18,80 (.740)	23,90 (.941)	1,02 (.040)	178 B/U - 196 A/U - KX 21A	1.5
05 (solder) / 15 (crimp)	Male	18,80 (.740)	23,62 (.930)	1,70 (.067)	179 B/U - 316 U - 188 A/U - KX 22A - 50 CIS	1.4
06 (solder) / 16 (crimp)	Female	18,80 (.740)	23,90 (.941)	1,70 (.067)	179 B/U - 316 U - 188 A/U - KX 22A - 50 CIS	1.5
09 (solder) / 19 (crimp)	Male	21,50 (.846)	26,34 (1.037)	2,79 (.110)	180 B/U	1.5
10 (solder) / 20 (crimp)	Female	21,50 (.846)	26,83 (1.056)	2,79 (.110)	180 B/U	1.7

### 90° Solder/or Crimp Braid Type

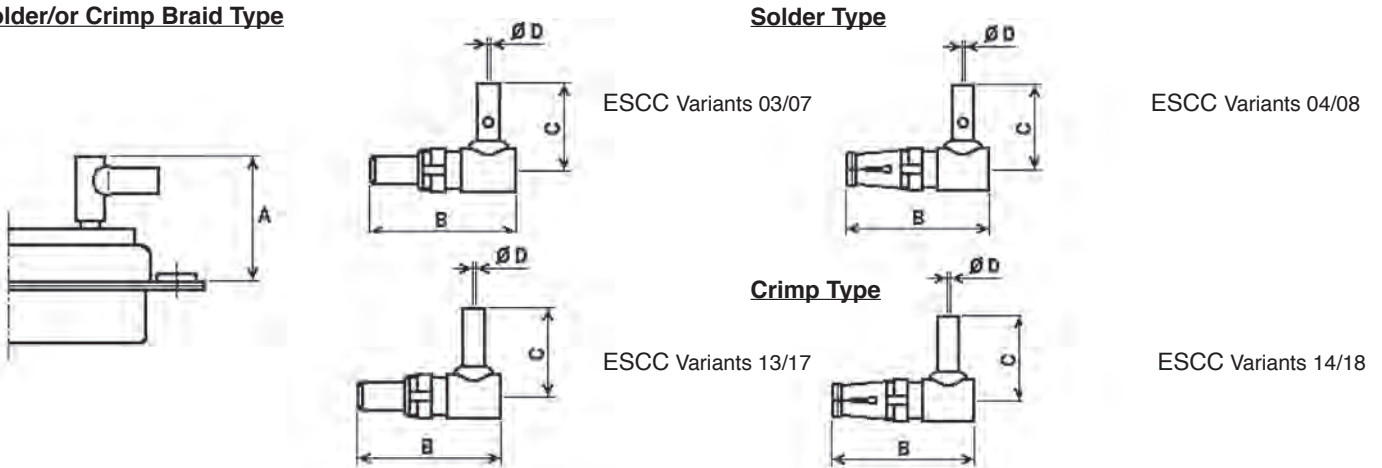

ESA/ESCC 3401 -004 xx Variant	Type	A max	B ± 0,45 (.018)	C Typical	D ± 0,13 (.005)	Accepted Cables	Max Weight (grams)
03 (solder) / 13 (crimp)	Male	13,60 (.535)	18,67 (.735)	12,50 (.492)	1,02 (.040)	178 B/U - 196 A/U - KX 21A	2.0
04 (solder) / 14 (crimp)	Female	13,60 (.535)	18,98 (.747)	12,50 (.492)	1,02 (.040)	178 B/U - 196 A/U - KX 21A	2.2
07 (solder) / 17 (crimp)	Male	13,60 (.535)	18,67 (.735)	12,50 (.492)	1,70 (.067)	179 B/U - 316 U - 188 A/U - KX 22A - 50 CIS	2.0
08 (solder) / 18 (crimp)	Female	13,60 (.535)	18,98 (.747)	12,50 (.492)	1,70 (.067)	179 B/U - 316 U - 188 A/U - KX 22A - 50 CIS	2.2

# 3401-004 Coaxial / 3401-040 Power D\*M Contacts

## Coaxial Contacts PCB

### Straight PCB Type

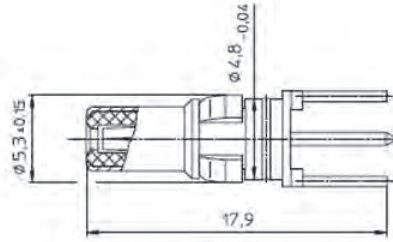
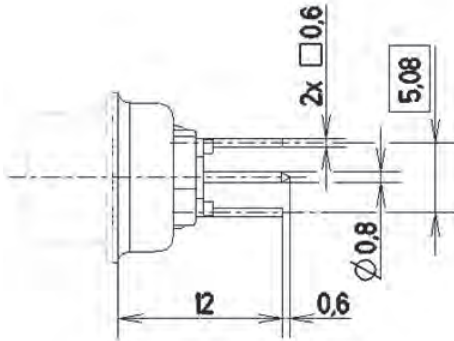

ESCC Variant 21

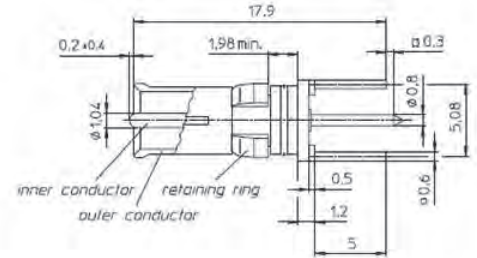

ESCC Variant 22

ESA/ESCC 3401-040 xx Variant	Type	Max Weight (grams)
21	Male	1.2
22	Female	1.0

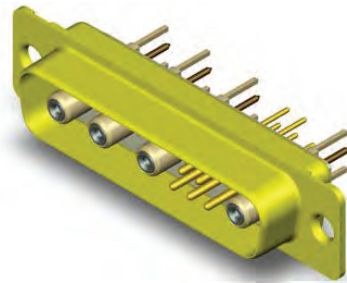

### 90° PCB Type

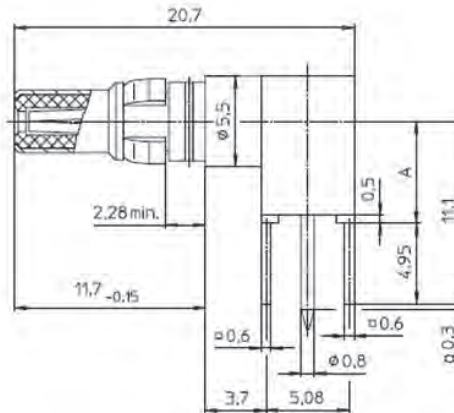
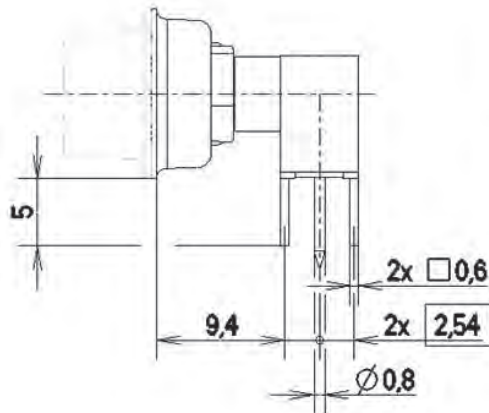

ESCC Variant 23

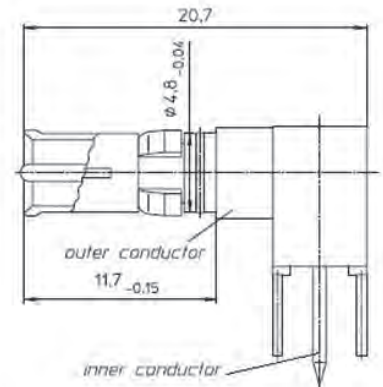

ESCC Variant 24

ESA/ESCC 3401-040 xx Variant	Type	Max Weight (grams)
23	Male	3.2
24	Female	3.0

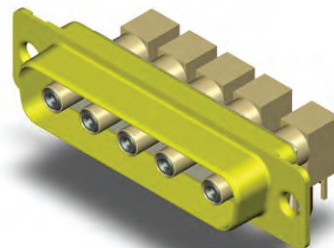

# 3401-004 Coaxial / 3401-040 Power D\*M Contacts

## Power Contacts

### Solder Braid Type

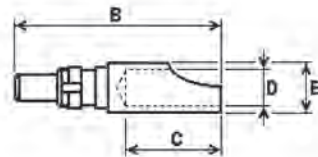
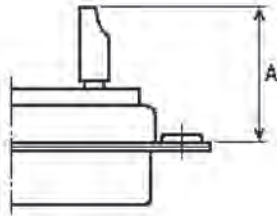

ESCC Variant 01

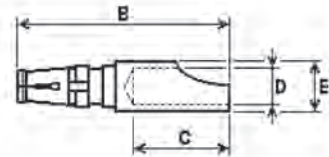

ESCC Variant 02

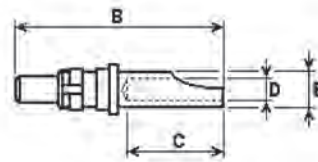

ESCC Variants 03/05

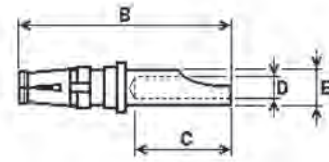

ESCC Variants 04/06

ESA/ESCC 3401-040 xx Variant	Type	A max	B max	C max	D max	E max	AWG	Max Weight (grams)
01 (solder)	Male	16,92 (.666)	22,10 (.870)	8,13 (.320)	4,90 (.193)	5,66 (.223)	8	2.20
02 (solder)	Female	16,92 (.666)	21,80 (.858)	8,13 (.320)	4,90 (.193)	5,66 (.223)	8	1.80
03 (solder)	Male	16,92 (.666)	22,10 (.870)	8,13 (.320)	3,00 (.118)	3,76 (.148)	12	2.15
04 (solder)	Female	16,92 (.666)	21,80 (.858)	8,13 (.320)	3,00 (.118)	3,76 (.148)	12	1.80
05 (solder)	Male	16,92 (.666)	22,10 (.870)	8,13 (.320)	1,90 (.075)	2,67 (.105)	16	2.00
06 (solder)	Female	16,92 (.666)	21,80 (.858)	8,13 (.320)	1,90 (.075)	2,67 (.105)	16	1.65

### Crimp Braid Type

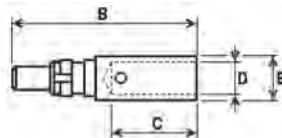
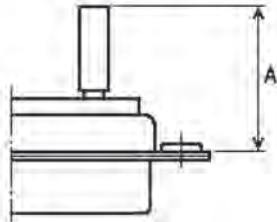

ESCC Variant 07

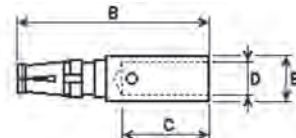

ESCC Variant 08

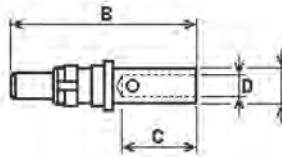

ESCC Variants 09/11

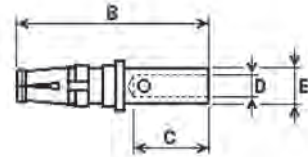

ESCC Variants 10/12

ESA/ESCC 3401-040 xx Variant	Type	A max	B max	C max	D min	E max	AWG	Max Weight (grams)
07 (crimp)	Male	19,00 (.748)	24,70 (.972)	11,10 (.437)	4,20 (.165)	5,80 (.228)	8	2.80
08 (crimp)	Female	19,00 (.748)	24,60 (.969)	11,10 (.437)	4,20 (.165)	5,80 (.228)	8	2.45
09 (crimp)	Male	19,00 (.748)	21,60 (.850)	8,40 (.331)	3,25 (.128)	4,70 (.185)	10	2.25
10 (crimp)	Female	19,00 (.748)	21,50 (.846)	8,40 (.331)	3,25 (.128)	4,70 (.185)	10	1.85
11 (crimp)	Male	19,00 (.748)	19,30 (.760)	6,35 (.249)	2,50 (.098)	3,80 (.150)	12	2.00
12 (crimp)	Female	19,00 (.748)	19,20 (.756)	6,35 (.249)	2,50 (.098)	3,80 (.150)	12	1.60

# 3401-004 Coaxial / 3401-040 Power D\*M Contacts

## Power Contacts PCB

### Straight PCB Type

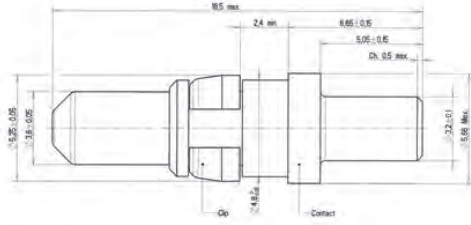
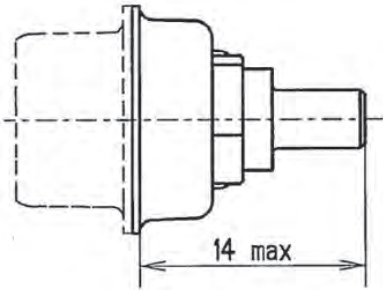

ESCC Variant 13

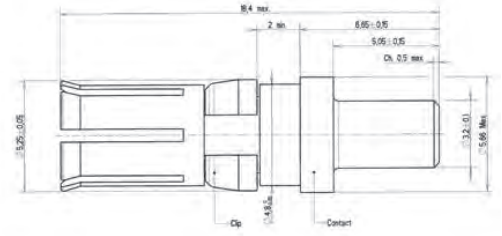

ESCC Variant 14

ESA/ESCC 3401-040 xx Variant	Type	Max Weight (grams)
13	Male	2.75
14	Female	1.75

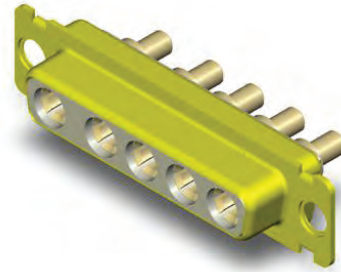

### 90° PCB Type

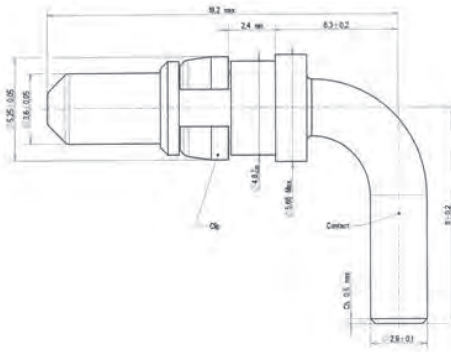
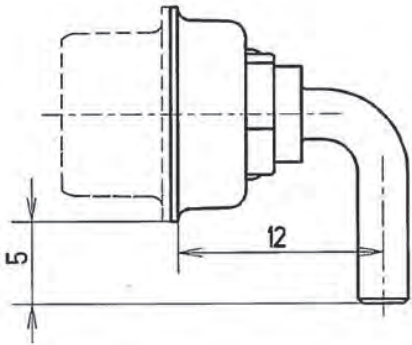

ESCC Variant 15

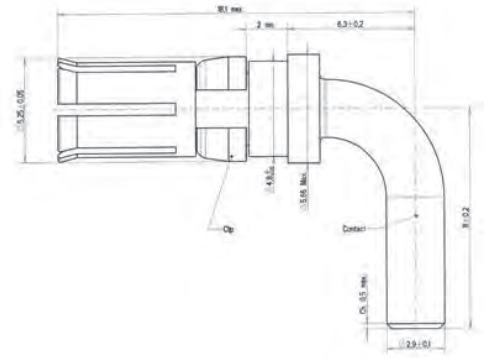

ESCC Variant 16

ESA/ESCC 3401-040 xx Variant	Type	Max Weight (grams)
15	Male	2.65
16	Female	2.45

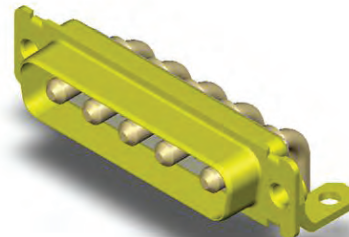



# 3401-004 Coaxial / 3401-040 Power D\*M Contacts

## Insertion/Extraction Instructions

### Insertion Tool

No insertion tool is required.  
The contact is easily snapped in from the rear of the connector manually.

### Insertion Instructions

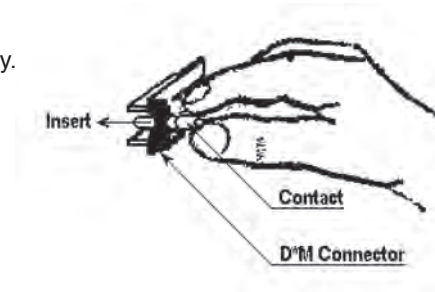

### Extraction Tool

Extraction tool CET-C6B-2 (Part number 070064-0002)



### Operating Instructions

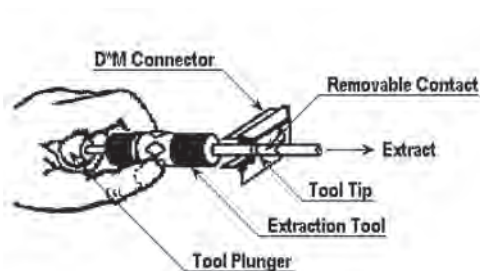

To extract the contact, hold the tool by the body and insert the tip into the front of the contact cavity until it bottoms and closes the contact retaining ring. Holding the body in this position securely enough to keep contact retaining ring closed, push the plunger. Contact will be pushed out of the rear of the assembly.

### Maximum Recess of Contacts relative to Shell Front

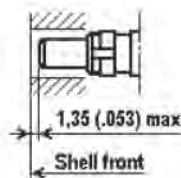

Male contact

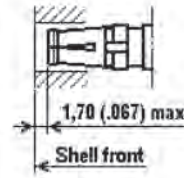

Female contact

# 3401-004 Coaxial / 3401-040 Power D\*M Contacts

## Coaxial Contacts Assembly Instructions

### Recommended Coaxial Cable Trim Dimensions

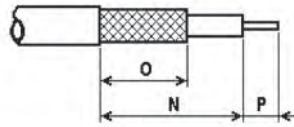

Crimp tool with integral die set for all contacts  
CCT-DM (Part number 070051-0000)

Hand tool HX4 (M22520/5-01)  
Die set Y322

Cable Type	Reference Specification
RG 178 B/U	MIL-C-17
RG 196 A/U	MIL-C-17
RG 179 B/U	MIL-C-17
RG 316 U	MIL-C-17
RG 188 A/U	MIL-C-17
RG 180 B/U	MIL-C-17
KX 21A	NF C 93-550
KX 22A	NF C 93-550
50 CIS	ESA/ESCC 3902/001

Dimensions (mm) / Tolerances $\pm 0,25$	N (Straight)	O (Straight)	P (Straight)	N (90°)	O (90°)	P (90°)	Tool	Closure
178 B/U – 196 A/U – KX 21A	7,92	6,35	1,98	9,52	5,94	1,57	CCT-DM	C
179 B/U – 316 U – 188 A/U – KX 22A – 50 CIS	7,92	6,35	1,98	9,52	5,94	1,57	CCT-DM	B
180 B/U	9,52	7,92	1,98	10,69	7,92	2,39	CCT-DM	A

Dimensions (inch) / Tolerances $\pm .010$	N (Straight)	O (Straight)	P (Straight)	N (90°)	O (90°)	P (90°)	Tool	Closure
178 B/U – 196 A/U – KX 21A	.312	.250	.078	.375	.234	.062	CCT-DM	C
179 B/U – 316 U – 188 A/U – KX 22A – 50 CIS	.312	.250	.078	.375	.234	.062	CCT-DM	B
180 B/U	.375	.312	.078	.422	.312	.094	CCT-DM	A

### Straight Braid Type

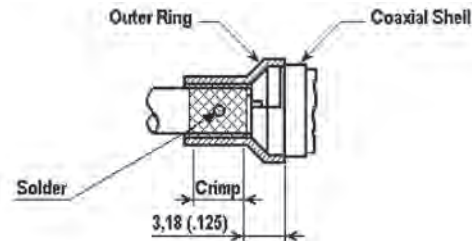
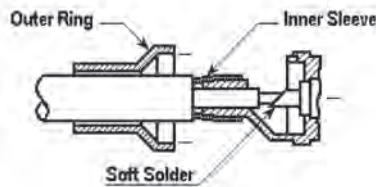

### 90° Braid Type

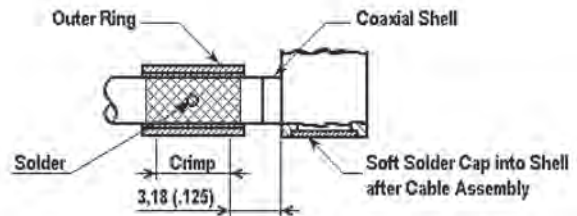
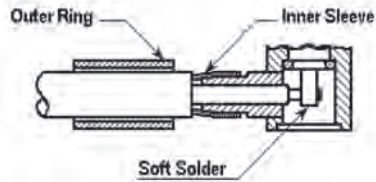

#### Step 1

Slide the outer ring over the cable jacket. Trim the cable as specified in the table. Insert the cable dielectric and center conductor into the inside diameter of the inner sleeve. Then solder the center conductor to the coax center contact.

#### Step 2

Slide the outer ring forward until it is flush with the coax shell containing the braid between the outer ring and the inner sleeve. For solder type coaxes, soft solder the outer ring to the assembly thru the cross drilled solder hold. For crimp type coaxes, crimp with the appropriate tool in the area defined.

# 3401-004 Coaxial / 3401-040 Power D\*M Contacts

## Power Contacts Assembly Instructions

### Recommended Wire Trim Length

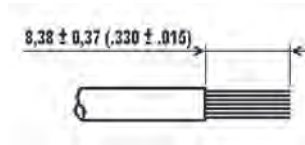

### Hand Crimp Tool

Crimp tool: M300-BT

Locator UH2-5 (Universal positioner M22520/1-05)

(Set the depth D from the front side, with the rear screw, according to the table below)



ESA/ESCC 3401-040 xx Variant	Type	Wire Size	Selector Position Note *	Locator Depth D $\pm 0,02$ (.001)	Tensile Strength min
07 (crimp)	Male	AWG 8	6	22,5 (.886)	50 daN
08 (crimp)	Female	AWG 8	6	24,0 (.945)	50 daN
09 (crimp)	Male	AWG 10	2	21,0 (.827)	50 daN
10 (crimp)	Female	AWG 10	2	22,5 (.886)	50 daN
11 (crimp)	Male	AWG 12	1	19,0 (.748)	30 daN
12 (crimp)	Female	AWG 12	1	21,0 (.827)	30 daN

Note \*: For information. Crimp tensile strength test shall govern.

AWG 8: 40 Amp contacts

AWG 10: 20 Amp contacts

AWG 12: 10 Amp contacts



# 3401-004 Coaxial / 3401-040 Power D\*M Contacts

## Cross References / Coaxial Contacts

ESA/ESCC Quality Level		FR023 Quality Level		FR022 Quality Level	
Description	Part Number	Description	Part Number	Description	Part Number
340100401B	C053740-5036C	DM115740-5036-FR023	C115740-5036E	DM115740-5036	C115740-5036
340100402B	C053742-5028C	DM115742-5028-FR023	C115742-5028E	DM115742-5028	C115742-5028
340100403B	C053741-5048C	DM115741-5048-FR023	C115741-5048E	DM115741-5048	C115741-5048
340100404B	C053743-5064C	DM115743-5064-FR023	C115743-5064E	DM115743-5064	C115743-5064
340100405B	C053740-5046C	DM115740-5046-FR023	C115740-5046E	DM115740-5046	C115740-5046
340100406B	C053742-5039C	DM115742-5039-FR023	C115742-5039E	DM115742-5039	C115742-5039
340100407B	C053741-5032C	DM115741-5032-FR023	C115741-5032E	DM115741-5032	C115741-5032
340100408B	C053743-5040C	DM115743-5040-FR023	C115743-5040E	DM115743-5040	C115743-5040
340100409B	C053740-5047C	DM115740-5047-FR023	C115740-5047E	DM115740-5047	C115740-5047
340100410B	C053742-5075C	DM115742-5075-FR023	C115742-5075E	DM115742-5075	C115742-5075
340100411B	C053740-0019C	DM115740-19-FR023	C115740-0019E	DM115740-19	C115740-0019
340100412B	C053742-0015C	DM115742-15-FR023	C115742-0015E	DM115742-15	C115742-0015
340100413B	C053741-0007C	DM115741-7-FR023	C115741-0007E	DM115741-7	C115741-0007
340100414B	C053743-0020C	DM115743-20-FR023	C115743-0020E	DM115743-20	C115743-0020
340100415B	C053740-0013C	DM115740-13-FR023	C115740-0013E	DM115740-13	C115740-0013
340100416B	C053742-0014C	DM115742-14-FR023	C115742-0014E	DM115742-14	C115742-0014
340100417B	C053741-0008C	DM115741-8-FR023	C115741-0008E	DM115741-8	C115741-0008
340100418B	C053743-0022C	DM115743-22-FR023	C115743-0022E	DM115743-22	C115743-0022
340100419B	C053740-0012C	DM115740-12-FR023	C115740-0012E	DM115740-12	C115740-0012
340100420B	C053742-0013C	DM115742-13-FR023	C115742-0013E	DM115742-13	C115742-0013
340100421B	C115366-2137C			DM115440-2A	C115440-0002
340100422B	C115366-2138C			DM115440-3A	C115440-0003
340100423B	C115366-2139C			DM115440-4A	C115440-0004
340100424B	C115366-2140C			DM115440-5A	C115440-0005

## Cross References / Power Contacts

ESA/ESCC Quality Level		FR023 Quality Level		FR022 Quality Level	
Description	Part Number	Description	Part Number	Description	Part Number
340104001B	C115224-1040C	DM115224-1040-FR023	C115224-1040E	DM115224-1040A	C115224-1040A
340104002B	C115224-2040C	DM115224-2040-FR023	C115224-2040E	DM115224-2040A	C115224-2040A
340104003B	C115224-1020C	DM115224-1020-FR023	C115224-1020E	DM115224-1020A	C115224-1020A
340104004B	C115224-2020C	DM115224-2020-FR023	C115224-2020E	DM115224-2020A	C115224-2020A
340104005B	C115224-1010C	DM115224-1010-FR023	C115224-1010E	DM115224-1010A	C115224-1010A
340104006B	C115224-2010C	DM115224-2010-FR023	C115224-2010E	DM115224-2010A	C115224-2010A
340104007B	C115224-3040C	DM115224-3040-FR023	C115224-3040E	DM115224-3040A	C115224-3040A
340104008B	C115224-4040C	DM115224-4040-FR023	C115224-4040E	DM115224-4040A	C115224-4040A
340104009B	C115224-3020C	DM115224-3020-FR023	C115224-3020E	DM115224-3020A	C115224-3020A
340104010B	C115224-4020C	DM115224-4020-FR023	C115224-4020E	DM115224-4020A	C115224-4020A
340104011B	C115224-3010C	DM115224-3010-FR023	C115224-3010E	DM115224-3010A	C115224-3010A
340104012B	C115224-4010C	DM115224-4010-FR023	C115224-4010E	DM115224-4010A	C115224-4010A
340104013B	C115366-2185C			DM115440-10A	C115440-0010
340104014B	C115366-2186C			DM115440-11A	C115440-0011
340104015B	C115366-2187C			DM115440-12A	C115440-0012
340104016B	C115366-2188C			DM115440-13A	C115440-0013



*Dimensions are shown in mm (inch)  
Dimensions subject to change*



*Dimensions are shown in mm (inch)  
Dimensions subject to change*



*Dimensions are shown in mm (inch)  
Dimensions subject to change*



*Dimensions are shown in mm (inch)  
Dimensions subject to change*